

BUTTERFLY

Garden Rollaway 6000 Table Tennis Table Assembly Instructions



BUTTERFLY

PARTS LIST

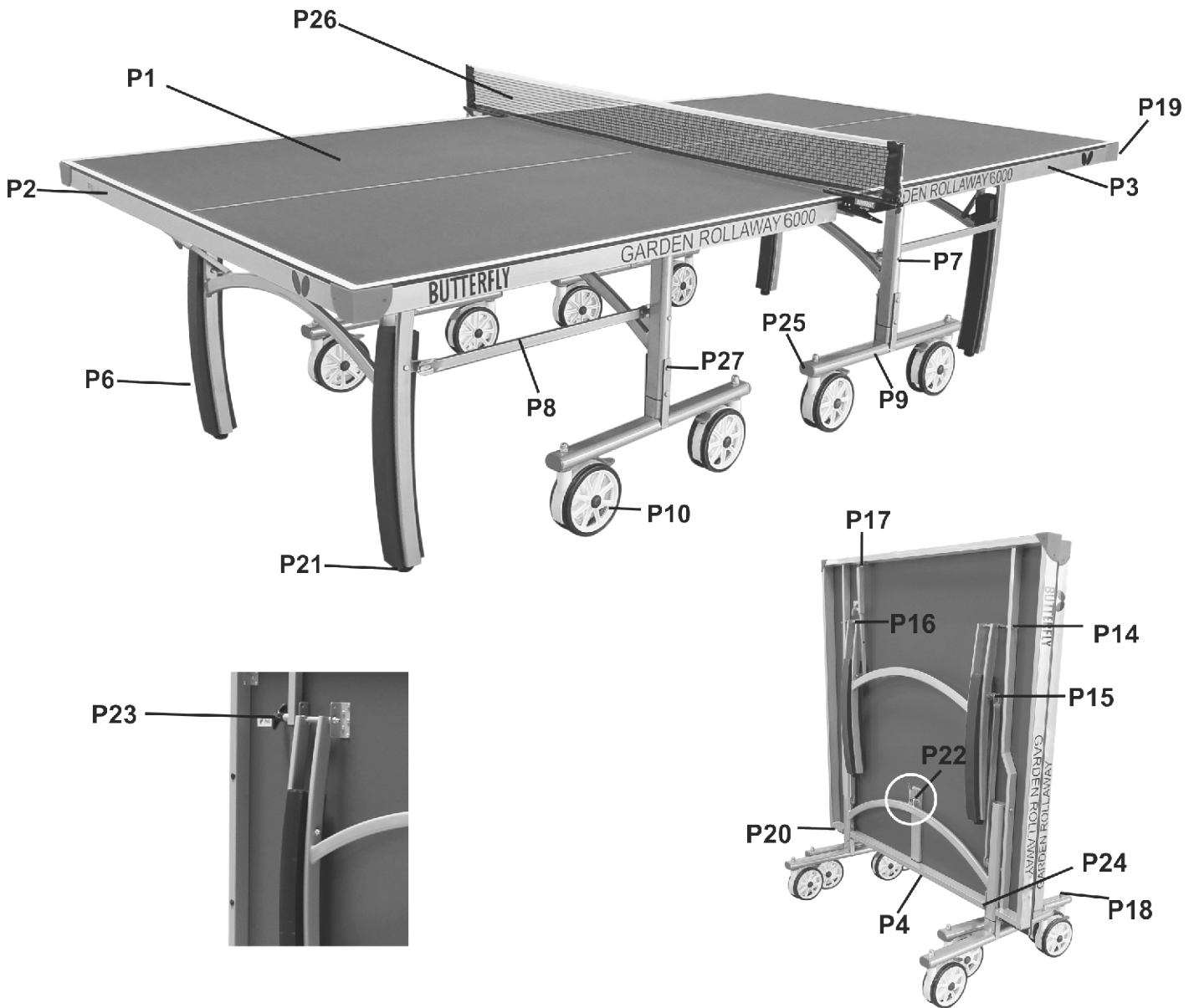

1. TABLE TOP 6 MM MELAMINE BOARD- - 2 NOS.
2. END FRAME PIPE - 2 NOS.
3. SIDE FRAME PIPE - 4 NOS.
4. INNER FRAME PIPE - 2 NOS.
5. SMALL INNER FRAME PIPE - 4 NOS.
6. OUTER LEG - 2 NOS.
7. INNER LEG - 2 NOS.
8. LONG BRACE SUPPORT- 4 NOS.
9. WHEEL ASSEMBLY- 4NOS.
10. SET OF 8 WHEELS - 2 LOCK WHEELS
11. XXXXXXX
12. XXXXXXX
13. XXXXXXX
14. BOLTS FOR OUTER/INNER LEG - 8 NOS.
15. BOLTS FOR LONG BRACE SUPPORT FIXED TO OUTER/INNER LEG - 6 NOS.
16. BOLTS FOR SIDE LOCK ATTACHED TO OUTER LEG - WITH NUT WASHER AND BHOGLI - 2NOS.

17. BOLTS FOR SIDE LOCK ATTACHED TO BRACKET - 2 NOS.
18. DOME NUT - 8 NOS.
19. OUTER CORNER - 4 NOS.
20. SET OF POST CORNER - 2 NOS.
21. LEVELLERS - 4 NOS.
22. CENTRE LOCK - 2 NOS.
23. SIDE LOCK - 2 NOS.
24. PLASTIC CAPS FOR INNER FRAME PIPE - 8 NOS.
25. WHEEL ASSEMBLY CAP - 8 NOS.
26. NET POST SET - 1 NOS.
27. BOLTS TO ATTACHED WHEEL ASSEMBLY(P9) WITH INNER LEG (P7) - 8 NOS.
28. SPARE NET - 1 NOS.
29. SPANNER - 2 NOS.
30. NUT AND BOLT - 4 NOS.
31. WOOD PART FOR LEGS - 4 NOS.

BUTTERFLY



P-27 QTY. - 8

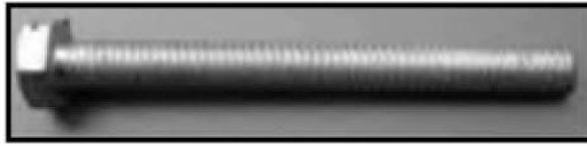

P-27 QTY. - 8

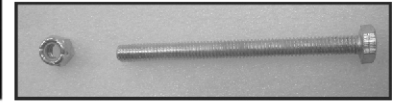

P-30 QTY. - 4



P-29- QTY. - 2

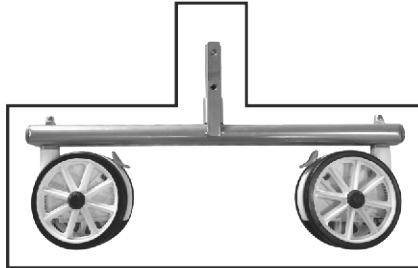

P-9 - QTY. - 4

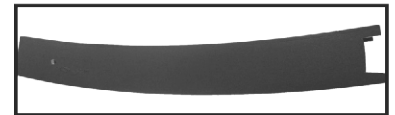

P-31 - QTY. - 4

ADULT ASSEMBLY REQUIRED

PLEASE READ THE SAFETY INSTRUCTIONS AT THE BOTTOM OF PAGE- 4

STEP - 1

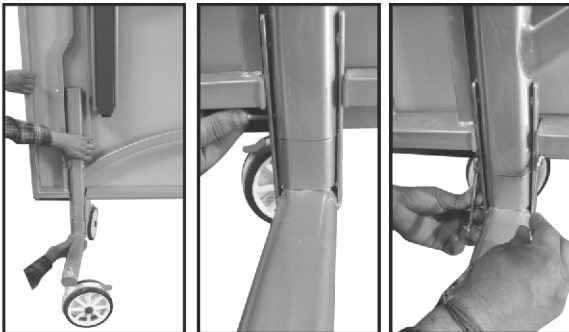

FIX THE WHEEL ASSEMBLY (P9) TO BOTH INNER (P7) LEGS OF EACH HALF OF THE TABLE USING NUT & BOLTS (P27) & TIGHTEN IT WITH THE HELP OF 2 SPANNERS.

STEP - 2

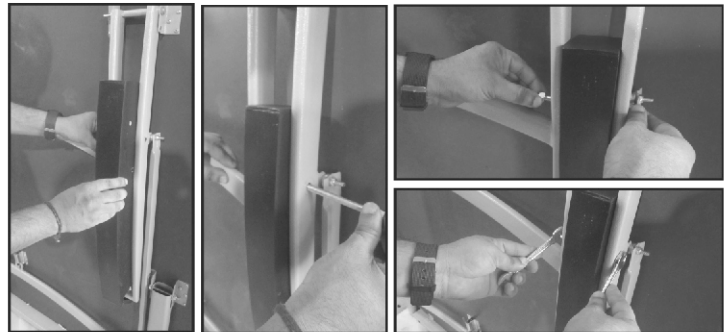

ATTACH P31 BETWEEN OUTER LEGS WITH THE HELP OF NUT AND BOLT P30 AND TIGHTEN IT WITH THE HELP OF TWO SPANNER.

STEP- 3

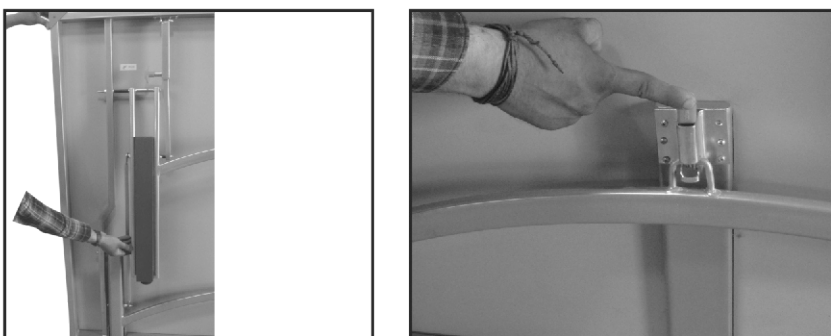

SLIGHTLY PULL OUT THE OUTER LEGS (P6) & PUSH OPEN THE TABLE SLIGHTLY BY OPENING CENTRE LOCK (P22).



BUTTERFLY

STEP- 4



NOW SLIGHTLY PULL OUT THE SIDE LOCK (P23) & SLOWLY BRING DOWN THE TABLE

STEP- 5

REPEAT THE SAME FOR THE 2ND HALF OF THE TABLE AS IN STEP- 1, 2, 3 & 4

STEP- 6

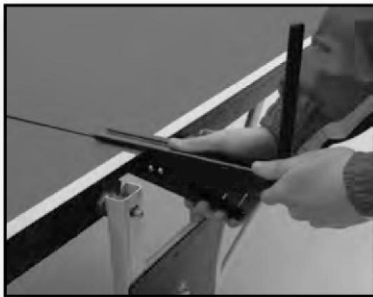

Attach posts to the left and right side of the table.

STEP- 7



Place net onto posts, feed string through grooves.

Adjust tension of the net with the chains.

STEP- 8

ADJUST THE HEIGHT REQUIRED WITH THE HELP OF LEVELLERS (P21) ATTACHED ON ALL 4 OUTER LEGS (P6).

YOUR TABLE IS NOW READY FOR PLAY

STEP- 1

STORING THE TABLE

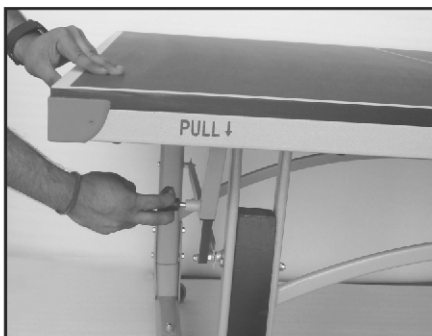

PULL OUT THE SIDE LOCK (P23) TO LIFT THE TABLE ON THE WHEELS. MAKE SURE THAT LOCK (P22) IS LOCKED PROPERLY FOR STORAGE

STEP- 2 REPEAT THE SAME FOR THE 2ND HALF.

Safety Instructions: "Children under 14 years of age should not be allowed to roll out the table, unlock it and place it in the playing position, or close the table and return it to the storage position. When lowering each half of the table top, make sure that the outer legs P6 are pulled gently away from the underside of the table. This table is suitable for both indoor and outdoor use. As far as possible the table should be stored indoors. Always cover the table when not in use. Check the wheel brakes are off when moving the table and they are on again when the table is in the play and storage position"